

User Manual

Washing Machine

WE 170 V



Electrolux
PROFESSIONAL

CONTENTS

1. SAFETY INFORMATION.....	3
2. PRODUCT DESCRIPTION.....	8
3. BEFORE FIRST USE.....	10
4. CONTROL PANEL.....	10
5. PROGRAMMES.....	12
6. CONSUMPTION VALUES.....	14
7. OPTIONS.....	15
8. SETTINGS.....	16
9. DAILY USE.....	16
10. HINTS AND TIPS.....	20
11. CARE AND CLEANING.....	22
12. TROUBLESHOOTING.....	24
13. EMERGENCY DOOR OPENING.....	26
14. TECHNICAL DATA.....	27
15. ENVIRONMENTAL CONCERNS.....	27

WE'RE THINKING OF YOU

Thank you for purchasing an Electrolux Professional appliance. You've chosen a product that brings with it decades of professional experience and innovation. Ingenious and stylish, it has been designed with you in mind. So whenever you use it, you can be safe in the knowledge that you'll get great results every time. Welcome to Electrolux Professional.

Visit our website www.electroluxprofessional.com/mypro/ to:



Get usage advice, brochures, trouble shooter, service and repair information:



Register your product for better service:



Buy Accessories, Consumables and Original spare parts for your appliance:

CUSTOMER CARE AND SERVICE

Always use original spare parts.

When contacting our Authorised Service Centre, ensure that you have the following data available: Model, PNC, Serial Number.

The information can be found on the rating plate.

 Warning / Caution-Safety information

 General information and tips

 Environmental information

Subject to change without notice.

1. ⚠ SAFETY INFORMATION

Before the installation and use of the appliance, carefully read the supplied instructions. The manufacturer is not responsible for any injuries or damage that are the result of incorrect installation or usage. Always keep the instructions in a safe and accessible location for future reference.

1.1 Children and vulnerable people safety

- This appliance can be used by children aged from 8 years and above and persons with reduced physical, sensory or mental capabilities or lack of experience and knowledge if they have been given supervision or instruction concerning the use of the appliance in a safe way and understand the hazards involved.
- Children between 3 and 8 years of age and persons with very extensive and complex disabilities shall be kept away from the appliance unless continuously supervised.
- Children of less than 3 years of age should be kept away from the appliance unless continuously supervised.
- Do not let children play with the appliance.
- Keep all packaging away from children and dispose of it appropriately.
- Keep detergents away from children.
- Keep children and pets away from the appliance when the door is open.
- Children shall not carry out cleaning and user maintenance of the appliance without supervision.

1.2 Installation

- This appliance is designed for washing clothes, linen, household goods made of woven and nonwoven materials and other products for which the manufacturer permits washing in automatic washing machines, both for domestic purposes and for professional purposes in

institutions and organizations (including mini-hotels, hotels, kindergartens, schools, medical facilities, factories and industrial enterprises, laundries, beauty salons, catering establishments, sports clubs, fitness centers and others similar institutions and organizations).

- Follow the installation instructions supplied with the appliance.
- Remove all the packaging and the transit bolts.
- Keep the transit bolts in a safe place. If the appliance is to be moved in the future they must be reattached to lock the drum to prevent an internal damage.
- Always take care when moving the appliance as it is heavy. Always use safety gloves and enclosed footwear.
- Do not install or use a damaged appliance.
- Make sure that the appliance is stable during transportation.
- Make sure that the appliance is disconnected from the electricity supply during installation, maintenance and repairs and cannot be reconnected until all work has been carried out.
- Do not install or use the appliance where the temperature can be less than 0°C or where it is exposed to the weather.
- Make sure that all health and safety regulations are obeyed when the appliance is installed in a commercial/ public environment.
- Do not install the appliance in a moving platform (e.g. on a ship).
- The floor area on which the appliance is to be installed must be flat, stable, heat resistant and clean.
- Make sure that there is air circulation between the appliance and the floor.
- The ventilation openings in the base (if applicable) must not be obstructed by a carpet.
- Adjust the feet to have the necessary space between the appliance and the carpet.

- Do not install the appliance where the appliance door can not be fully opened.
- Do not put a container to collect possible water leakage under the appliance. Contact the Authorised Service Centre to ensure which accessories can be used.

1.3 Electrical Connection

- The appliance must be correctly earthed. The manufacturer is not responsible for the consequences of an inadequate earthing system.
- Always use a correctly installed shockproof socket.
- Make sure that the parameters on the rating plate are compatible with the electrical ratings of the mains power supply.
- Do not use multi-plug adapters and extension cables.
- Make sure not to cause damage to the mains plug and to the mains cable.
- If the supply cord is damaged, it must be replaced by the manufacturer, its Authorised Service Centre or similarly qualified persons in order to avoid a hazard.
- Connect the mains plug to the mains socket only at the end of the installation. Make sure that there is access to the mains plug after the installation.
- Do not touch the mains cable or the mains plug with wet hands.
- Do not pull the mains cable to disconnect the appliance. Always pull the mains plug.
- Only for UK and Ireland: The appliance has a 13 A mains plug. If it is necessary to change the fuse in the mains plug, use a 13 A ASTA (BS 1362) fuse.

1.4 Water connection

- Do not cause damage to the water hoses.
- The appliance is to be connected to the water mains using the new supplied hose-sets. Old hose sets must not be reused.

- Before connection to new pipes, pipes not used for a long time, where repair work has been carried out or new devices fitted (water meters, etc.), let the water flow until it is clean and clear.
- The operating water pressure (minimum and maximum) must be between 0.5 bar (0.05 MPa) and 10 bar (1.0 MPa).
- Ensure that there are no visible water leaks during and after the first use of the appliance.

1.5 Use

- Do not change the specification of this appliance.
- Obey the safety instructions on the detergent packaging.
- Obey the maximum load volume of 8 kg (refer to the “Programme chart” chapter).
- Do not put flammable products or items that are wet with flammable products in, near or on the appliance.
- Make sure that you remove all metal objects from the laundry.
- Do not touch the glass of the door while a programme operates. The glass can be hot.

1.6 Care and cleaning

- Before maintenance, deactivate the appliance and disconnect the mains plug from the mains socket.
- Do not use water spray and steam to clean the appliance.
- Clean the appliance with a moist soft cloth. Use only neutral detergents. Do not use abrasive products, abrasive cleaning pads, solvents or metal objects.

1.7 Internal lighting



- Visible LED radiation, do not look directly into the beam.

- To replace the internal lighting, contact the Authorised Service Centre.

1.8 Service

- To repair the appliance contact the Authorised Service Centre. Use original spare parts only.
- Please note that self-repair or non-professional repair can have safety consequences and might void the guarantee.
- Concerning the lamp(s) inside this product and spare part lamps sold separately: These lamps are intended to withstand extreme physical conditions in household appliances, such as temperature, vibration, humidity, or are intended to signal information about the operational status of the appliance. They are not intended to be used in other applications and are not suitable for household room illumination.

1.9 Disposal

- Disconnect the appliance from the mains electrical and water supplies.
- Cut off the mains electrical cable close to the appliance and dispose of it.
- Remove the door catch to prevent children or pets from becoming trapped in the drum.

2. PRODUCT DESCRIPTION

2.1 Appliance overview

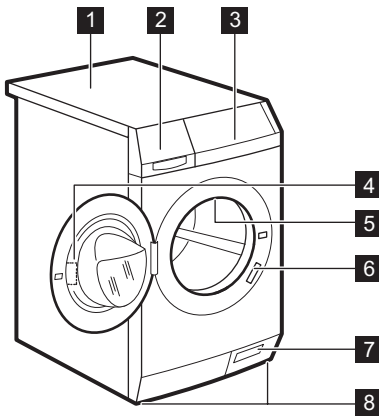

- 1** Worktop
- 2** Detergent dispenser
- 3** Control panel
- 4** Door handle
- 5** Internal light
- 6** Rating plate
- 7** Emergency door opening
- 8** Feet for levelling the appliance

2.2 Accessories

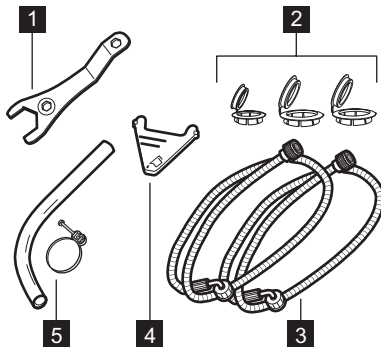

- 1** **Spanner**
To remove the transit bolts.
- 2** **Plastic caps**
To close the holes on the rear side of the cabinet after the removal of the transit bolts.
- 3** **Inlet hoses**
To connect the appliance to the cold and hot water tap: blue cap hose for cold water and red cap hose for hot water.
- 4** **Flap for liquid detergent**
To slow down the liquid detergent flow.
- 5** **Drain hose and clamp**
To connect the appliance to a drain system. Use the clamp to fix the drain hose tight. If necessary, the drain hose can be cut and shortened.

2.3 Available from your authorized vendor

- i** Only appropriate accessories approved by Electrolux ensure the safety standards of the appliance. If unapproved parts are used, any claims will be invalidated.

Stacking kit

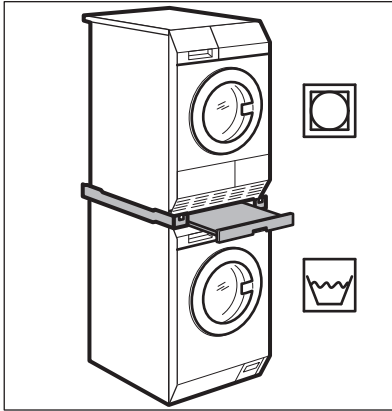

Stacking kit can be used only with the tumble dryers specified in the leaflet. See the leaflet attached. Read carefully the instructions supplied with the accessory.

Pedestal with the drawer

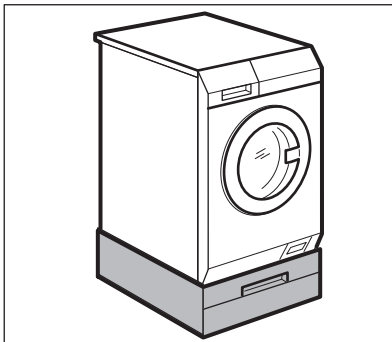

To put the appliance higher at the level what helps to easy load and remove the laundry.

The drawer can be used for laundry storage e.g.: towels, cleaning products and more.

Read carefully the instructions supplied with the accessory.

Anchoring kit

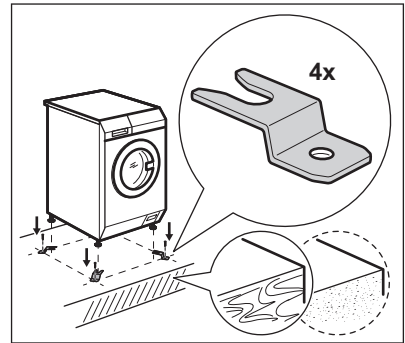

If you install the appliance on a concrete base, please make sure to order the correct anchoring kit.

Read carefully the instructions supplied with the accessory.

External detergent dispenser

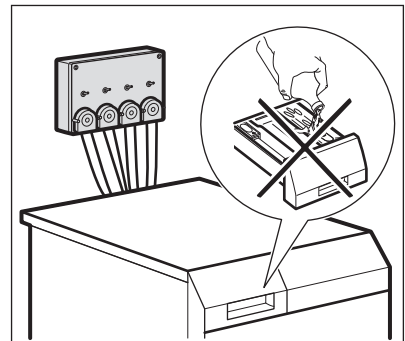

The liquid detergent can be loaded automatically from an external dispenser.

Read carefully the instructions supplied with the accessory.

3. BEFORE FIRST USE

1. Make sure that all transit bolts are removed.
2. Make sure that the electrical and water connection are available.
3. Put 2 litre of water in the detergent compartment for washing phase. This activates the drain system.
4. Put a small quantity of detergent in the compartment for washing phase.
5. Set and start a programme for cotton at the highest temperature without laundry. This removes all possible dirt from the drum and the tub.

4. CONTROL PANEL

4.1 Control panel description

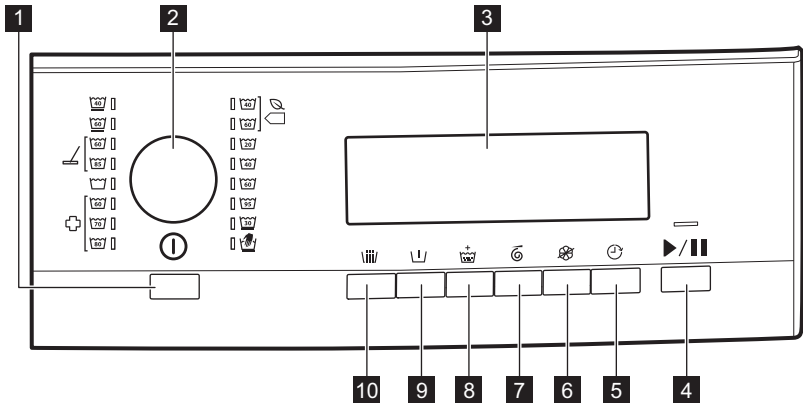

1 Auto Off button 

2 Programme knob

3 Display

4 Start/Pause button 

5 Delay start button 

6 No softener button 

7 Spin time button 

8 Extra rinse button 

9 Pre wash button 





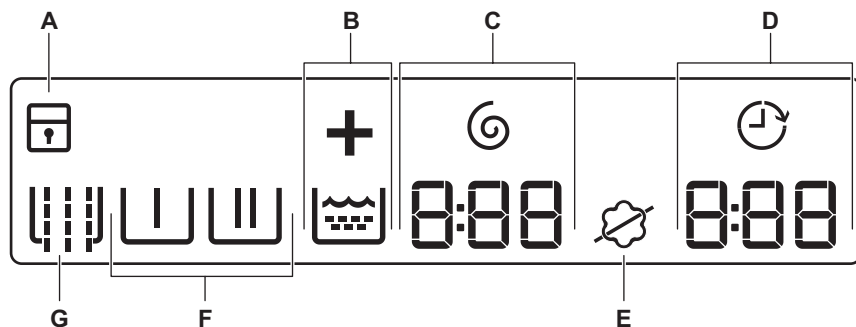

10 Pre rinse button 

4.2 Display







The display shows:













A		The child safety lock is activated.
		The child safety lock is deactivated.
B	 	Extra rinse symbol. is the symbol indicating the rinse phase and + lights up when the Extra rinse is selected.
C	 	Spin time indicator and symbol. The digit indicates minutes and seconds.
D	 	Delay start indicator.
		Programme time When the programme starts, the programme time decreases with steps of 1 minute. The digit indicates hours and minutes.
		Delay start When you press the delay start button, the display shows the delay start time
		Alarm codes If the appliance has a malfunction, the display shows alarm codes. Refer to «Troubleshooting».
		The display shows this message for some seconds when: <ul style="list-style-type: none"> • you cannot set a function with the washing programme • you try to change the washing programme while it operates.
		When the programme is completed.

E		Softener symbol: the appliance does load softener normally.
		No softener symbol: the appliance doesn't load softener.
The phase symbols		
When a programme is set, all the symbols of the phases related to the programme come on.		
When the programme starts, only the symbol of the phase in operation flashes.		
When the phase is completed, the symbol remains steady lighted up.		
F		Pre wash phase
		Washing phase
		Rinse phase
		Spin phase
G		Pre rinse symbol

5. PROGRAMMES

5.1 Programme Chart

Programme Temperature range 1)	Maximum load 2) Reference spin speed Spin Time	Programme description (Type of load and level of soiling)
 Eco ³⁾ 	4 kg 1400 rpm 540 sec- onds - 5 seconds	White cotton and fast-coloured cotton. Normally soiled items. The energy consumption decreases and the time of the washing programme is extended, ensuring good washing results.
Normal 	8 kg 1400 rpm 360 sec- onds - 5 seconds	White cottons Normal soil and light soil. ⁴⁾
Normal 	8 kg 1400 rpm 360 sec- onds - 5 seconds	Coloured cottons Normal soil and light soil. ⁵⁾

Programme Temperature range 1)	Maximum load 2) Reference spin speed Spin Time	Programme description (Type of load and level of soiling)
Delicates 	4 kg 1200 rpm 120 seconds - 5 seconds	Delicate fabrics such as acrylics, viscose and mixed fabrics requiring gentler washing. Normally and lightly soiled items.
 Handwash 	2 kg 1200 rpm 120 seconds - 5 seconds	Machine washable wool, hand washable wool and other fabrics with «hand washing» care symbol ⁶⁾ .
Synthetics  	4 kg 1200 rpm 120 seconds - 5 seconds	Synthetic items or mixed fabric items. Normally soiled items.
 Mop  	8 kg 1400 rpm 240 seconds - 5 seconds	Programme for mops, work wear and special programme for microfibres. The programme performs an automatic pre rinse phase.
 Rinse	8 kg 1400 rpm 360 seconds - 5 seconds	To rinse and spin the laundry. All fabrics , except woollens and very delicate fabrics. Reduce the spin speed accordingly to the type of laundry.
 Disinfection   	8 kg 1400 rpm 360 seconds - 5 seconds	This programme removes dust mites and similar micro-organisms. The programme performs an automatic pre wash phase.

1) If connected, hot water is loaded only in the programme Eco, Normal, Synthetics, Mop and Disinfection when the set temperature is 40°C or higher.

2) For an optimal result, the maximum load indicated for each programme is recommended.







3) This programme at 60 °C with a load of 8 kg is the reference programme for energy label data, in compliance with GOST R IEC 60456:2010.

4) A detergent with bleach should be used.

5) A detergent without bleach should be used.

6) During this cycle the drum rotates slowly to ensure a gentle wash. It can seem that the drum doesn't rotate or doesn't rotate properly, but this is normal for this programme.

Programme options compatibility

Programme						
Eco 	■	■	■	■	■	■
Normal	■	■	■	■	■	■
Delicates 30°C	■	■	■	■	■	■
Handwash	■			■	■	■
Synthetics 40°-60°C	■	■	■	■	■	■
Mop	■ 1)		■	■	■	■
Rinse			■	■		■
Disinfection	■	■ 1)	■	■	■	■

1) This option is automatically performed and cannot be removed from the programme.

6. CONSUMPTION VALUES



Stated values are obtained in laboratory conditions with relevant standards. Different causes can change the data: the quantity and type of laundry and ambient temperature. Water pressure, the supply voltage and the temperature of inlet water may also affect the washing programme duration.



At the start of the programme, the display shows the programme duration for the maximum load capacity. During the washing phase the programme duration is automatically calculated and can be greatly reduced if the laundry load is lower than the maximum load capacity (e.g. Cotton 60°C, maximum load capacity 8 kg, the programme duration exceeds 2 hours; actual load 1 kg, the programme duration will be less than 1 hour). When the appliance is calculating the real programme duration a dot flashes in the display.

Programmes	Load (kg)	Water supply	Energy consumption (kWh)	Water consumption (litre)	Approximate programme duration (minutes)
Normal 60 °C	8	Hot and cold	0.60	62	70
Eco ¹⁾	8	Cold	1.00	51	220

Programmes	Load (kg)	Water supply	Energy consumption (kWh)	Water consumption (litre)	Approximate programme duration (minutes)
Normal 40 °C	8	Hot and cold	0.20	62	63
Synthetics 40 °C	4	Hot and cold	0.08	31	55
Delicates 30 °C	4	Cold	0.20	49	47
Handwash 40 °C	2	Cold	0.33	48	45

1) This programme at 60 °C with a load of 8 kg is the reference programme for energy label data, in compliance with GOST R IEC 60456:2010.

Off Mode (W)	Left On Mode (W)
0.05	0.05

The information given in the chart above is compliant with the EU Commission regulation 1015/2010 implementing directive 2009/125/EC .

7. OPTIONS

7.1 Pre rinse

Press this button to add a pre rinse phase without detergent before washing.

The related indicator comes on .

7.2 Pre wash

With this option you can add a prewash phase to a washing programme.

Use this option for heavy soil.

When you set this option the programme duration increases.

The related indicator comes on .

7.3 Extra rinse

With this option you can add some rinses to a washing programme.

Use this option for persons allergic to detergents and in areas where the water is soft.

The related indicator comes on .

7.4 Spin time

By pressing this button you can decrease the spin time. Once you reach the minimum time (5 seconds) it restarts from the maximum time again.

The related indicator comes on  .

7.5 No softener

Press this button to exclude the softener load.



The related indicator comes on .

Press this button again, the softener is loaded normally.

The related indicator comes on .

7.6 Delay start

With this option you can delay the start of a programme from 30 minutes to 70 hours.



The display shows the related indicator  .

8. SETTINGS

8.1 Acoustic signals

The acoustic signals operate when:



- You activate the appliance.
- You select a programme.
- You deactivate the appliance.
- You press the buttons.
- The programme is completed.
- The appliance has a malfunction.



To **deactivate/activate** the acoustic signals, press  and  at the same time for 6 seconds.

-  If you deactivate the acoustic signals, they continue operate when the appliance has a malfunction.



8.2 Child Lock

With this option you can prevent that the children play with the control panel.

- To **activate/deactivate** this option, press the  and  buttons simultaneously until the related indicator comes on in the display:

- : Child lock activated.
- : Child lock deactivated.



You can activate this option:

- After you press : the options and the programme knob are locked.
- Before you press : the appliance cannot start.

-  If the appliance is connected to coin operated machine, the child lock activates automatically 5 minutes after the programme start.

8.3 Permanent Extra Rinse

With this option you can permanently have an extra rinse when you set a new programme.

- To **activate/deactivate** this option press  and  at the same time until the indicator  comes on/goes off.

9. DAILY USE

 **WARNING!**
Refer to Safety chapters.

9.1 Loading the laundry

1. Pull the handle to open the appliance door
2. Shake the items before you put them in the appliance.
3. Put the laundry in the drum, one item at a time.

Make sure not to put too much laundry in the drum.

4. Close the door.

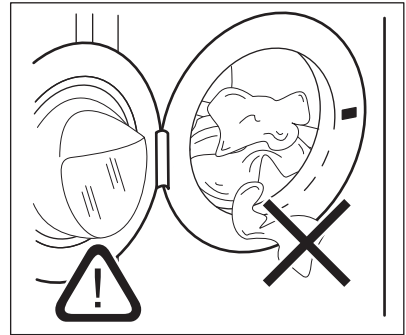

 **CAUTION!**

Make sure that no laundry stays between the seal and the door. There is a risk of water leakage or damage to the laundry.

9.2 Installing the flap for liquid detergent

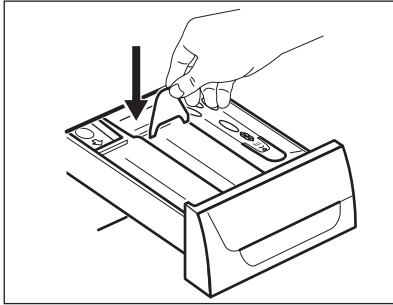

- Open the detergent dispenser.
- Install the flap for liquid detergent in the compartment .

2. Put the detergent and the fabric conditioner into the compartments.
3. Carefully close the detergent drawer

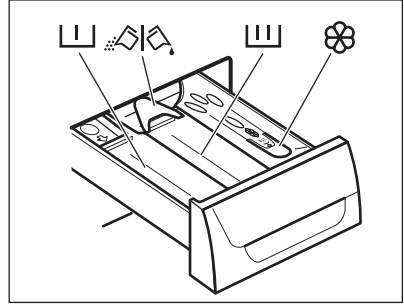

9.3 Using detergent and additives

1. Measure out the detergent and the fabric conditioner.

9.4 Detergent compartments







CAUTION!

Use only specified detergents for washing machine.



Always obey the instructions that you find on the packaging of the detergent products.

	Detergent compartment for prewash phase.
	Detergent compartment for washing phase.
	Compartment for liquid additives (fabric conditioner, starch).
	Flap for powder or liquid detergent.

9.5 Liquid or powder detergent

- Position A for powder detergent (factory setting).
- Position B for liquid detergent.



When you use the liquid detergent:

- Do not use gelatinous or thick liquid detergents.
- Do not put more liquid than the maximum level.
- Do not set the prewash phase.
- Do not set the delay start.

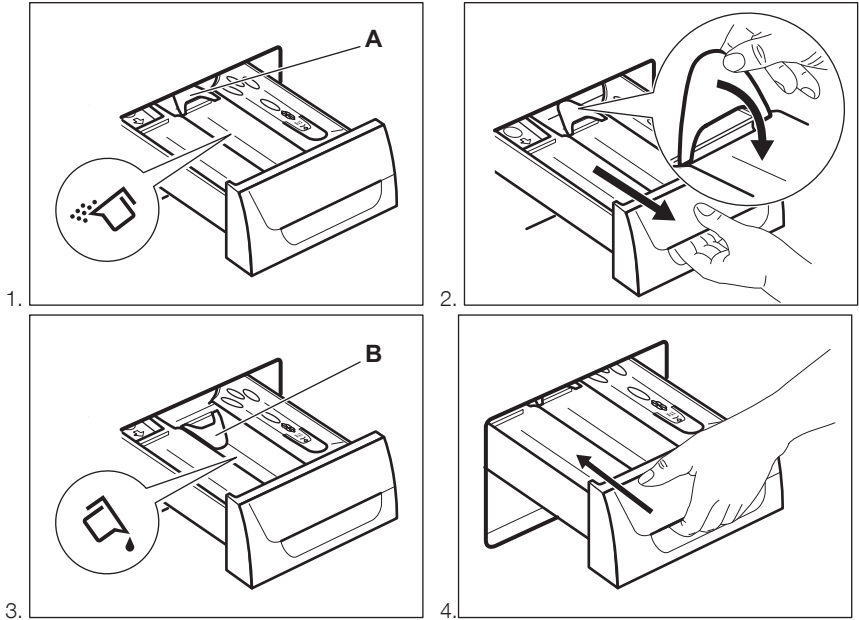

9.6 Activating the appliance

Press the button  to activate the appliance. A tune sounds (if it is activated).

9.7 Setting a programme

1. Turn the programme knob and set the programme:
 - The related programme indicator comes on. A tune sounds (if it is activated).
 - The indicator of button Start/Pause flashes.
 - The display shows the programme duration and the indicators of the programme phases.

2. If necessary, change the spin time and add the available options. When you activate an option, the indicator of the set option comes on.



If you set something incorrect, the display shows the message **E r r c**.

9.8 Starting a programme

Press the button .

- The indicator of the button  stops flashing and stays on.
- The indicator of the running phase starts flashing on the display.
- The programme starts and the door locks.

-  After approximately 15 minutes from the start of the programme:
- The appliance can adjust the programme duration automatically depending with the laundry load.
 - The display shows the new time to end.



9.9 Starting a programme with the delay start

1. Press Delay start repeatedly until the display shows the delay you want to set.

The related indicator comes on the display



2. Press Start/Pause :
 - The appliance starts the countdown.
 - When the countdown is completed, the programme starts automatically.

-  You can cancel or change the set of the delay start before you press Start/Pause. To cancel the delay start:
- Press Start/Pause to set the appliance to pause.
 - Press Delay start until the display shows .
 - Press Start/Pause again to start the programme immediately.

9.10 Cancelling the delay start

To cancel the delay start:

1. Press button Start/Pause to set the appliance to pause.
The related indicator flashes.
2. Press button Delay start repeatedly until the display shows .
3. Press button Start/Pause again to start the programme immediately.

9.11 Interrupting a programme and changing the options

You can change only some options before they operate.

1. Press Start/Pause .
The indicator flashes.
2. Change the options.
3. Press Start/Pause again.
The programme continues.

-  If the appliance is connected to a coin operated machine, you can interrupt a programme only 5 minutes after the programme start. After this time the child lock automatically activates.

9.12 Cancelling a running programme

1. Press the button  for some seconds to cancel the programme and to deactivate the appliance.



WARNING!

If the appliance has already uploaded water, the door remains locked.

2. Press the same button again to activate the appliance. Now, you can set a new washing programme.



Before starting the new programme the appliance could drain the water. In this case, make sure that the detergent is still in the detergent compartment, if not fill the detergent again.

9.13 At the end of the programme

The appliance stops automatically.

In the display  comes on.

The indicator of button  goes off.

The door unlocks.

1. Open the door.
2. Remove the laundry from the appliance. Make sure that the drum is empty.

3. Close the water tap.
4. Press the button  for some seconds to deactivate the appliance.

Keep the door ajar, to prevent the mildew and odours.

9.14 AUTO OFF option

The AUTO OFF option automatically deactivates the appliance to decrease the energy consumption when:

- You do not use the appliance for 5 minutes before you press the button .

Press the button  to activate the appliance again.

- After 5 minutes from the end of the washing programme

Press the button  to activate the appliance again.

The display shows the end of the last set programme.

Turn the programme knob to set a new cycle.

10. HINTS AND TIPS



WARNING!
Refer to Safety chapters.

10.1 The laundry load

- Divide the laundry in: white, coloured, synthetics, delicates and wool.
- Obey the washing instructions that are on the laundry care labels.
- Do not wash white and coloured items together.
- Some coloured items can discolour with the first wash. We recommend that you wash them separately for the first times.
- Turn multilayered fabrics, wool and items with painted illustrations inside out.
- Wash and pre-treat heavy soil stains with a suitable detergent before putting in drum.
- Be careful with the curtains. Remove the hooks and put the curtains in a washing bag or pillowcase.
- Do not wash laundry without hems or with cuts. Use a washing bag to wash small and/or delicate items (e.g. underwired bras, belts, tights, shoelaces, ribbons, etc.).

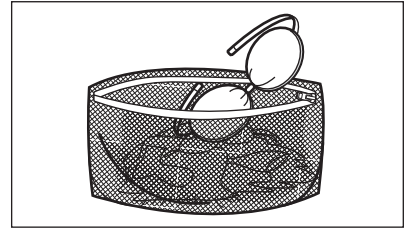

- A very small load can cause balance problems with the spin phase leading to excessive vibration. If this occurs:
 - interrupt the programme and open the door (refer to "Daily Use" chapter);
 - manually redistribute the load so that the items are spaced evenly around the tub;
 - press the Start/Pause button. The spin phase continues.
- Button up pillowcases, close zippers, hooks and poppers. Tie up belts, cords, shoelaces, ribbons and any other loose elements.
- Empty the pockets and unfold the items.

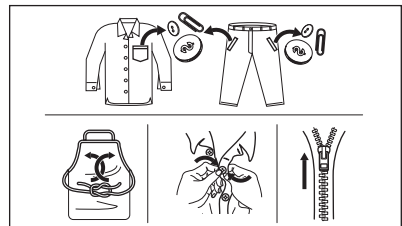

10.2 Stubborn stains

For some stains, water and detergent is not sufficient.

We recommend that you pre-treat these stains before you put the items in the appliance.

Special stain removers are available. Use the special stain remover that is applicable to the type of stain and fabric.

Do not spray stain remover on garments near the appliance as it is corrosive to the plastic parts.



10.3 Detergent type and quantity.

The choice of detergent and use of correct quantities not only affects your wash performance, but also helps to avoid waste and protect the environment:

- Use only detergents and other treatments specially made for washing machines. First, follow these generic rules:
 - powder detergents for all types of fabric, excluding delicate. Prefer powder detergents containing bleach for whites and laundry sanitization,
 - liquid detergents, preferably for low temperature wash programmes (60 °C max) for all types of fabric, or special ones for woollens only.
- The choice and quantity of detergent will depend on: type of fabric (delicates, woollens, cottons, etc), the colour of clothes, size of the load, degree of soiling, wash temperature and hardness of the water used.
- Follow the instructions that you find on packaging of the detergents or other treatments without exceeding the indicated maximum level (**MAX**).

- Do not mix different types of detergents.
- Use less detergent if:
 - you are washing a small load,
 - the laundry is lightly soiled,
 - there is large amounts of foam during washing.
- When using detergent tabs or pods, always put them inside the drum, not in the detergent dispenser.

Insufficient detergent may cause:

- unsatisfactory washing results,
- the wash load to turn grey,
- greasy clothes,
- mould in the appliance.

Excessive detergent may cause:

- sudsing,
- reduced washing effect,
- inadequate rinsing,
- a greater impact for the environment.

10.4 Ecological hints

To save water, energy and to help protect the environment, we recommend that you follow these tips:

- **Normally soiled laundry** may be washed **without prewash** in order to save detergent, water and time (the environment is protected too!).
- Loading the appliance to the **maximum capacity indicated for each programme helps to reduce energy and water consumption.**
- With adequate pre-treatment, stains and limited soiling can be removed; the laundry can then be washed at a lower temperature.
- To use the correct quantity of detergent, refer to the quantity suggested by the detergent producer and check the water hardness of your domestic system. Refer to "Water hardness".
- Set the **maximum possible spin speed** for the selected washing programme **before drying your laundry in a tumble dryer.** This will save energy during drying!

10.5 Water hardness

If the water hardness in your area is high or moderate, we recommend that you use

a water softener for washing machines. In areas where the water hardness is soft it is not necessary to use a water softener.

To know the water hardness in your area, contact your local water authority.

11. CARE AND CLEANING



WARNING!
Refer to Safety chapters.

11.1 External cleaning

Clean the appliance with soap and warm water only. Fully dry all the surfaces. Do not use a scouring pads or any scratching material.



CAUTION!
Do not use alcohol, solvents or chemical products.



CAUTION!
Do not use the metal surfaces with chlorine-based detergent.

11.2 Descaling

If the water hardness in your area is high or moderate, we recommend that you use a water descaling product for washing machines.

Regularly examine the drum to prevent limescale and rust particles.

To remove rust particles use only special products for washing machines. Do this separately from the laundry wash.



Always obey the instructions that you find on the packaging of the product.

11.3 Maintenance wash

With the low temperature programmes it is possible that some detergent stays in the

drum. Perform a maintenance wash regularly. To do this:

Use the correct quantity of the water softener. Obey the instructions that you find on the packaging of the product.

- Remove all laundry from the drum.
- Select the cotton programme with the highest temperature with a small quantity of detergent.

11.4 Door seal

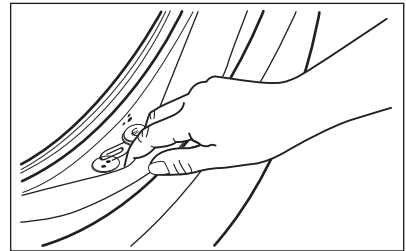

Regularly examine the seal and remove all objects from the inner part.

11.5 Cleaning the drum

Regularly examine the drum to prevent limescale and rust particles. Only use special products to remove rust particles from the drum.

We suggest you to:

1. Clean the drum with special product for stainless steel.
2. Start a short programme for cotton at the maximum temperature with a small quantity of detergent.

11.6 Cleaning the detergent dispenser

1.

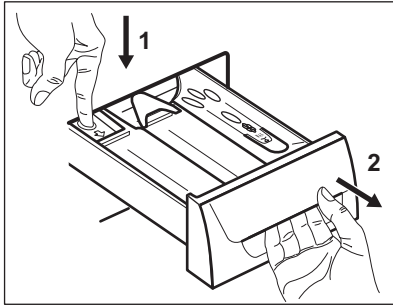

2.

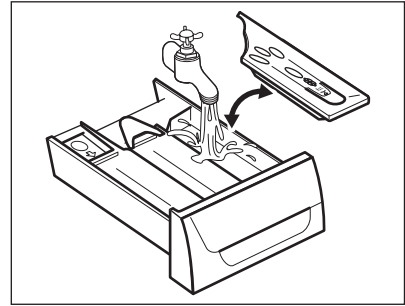

3.

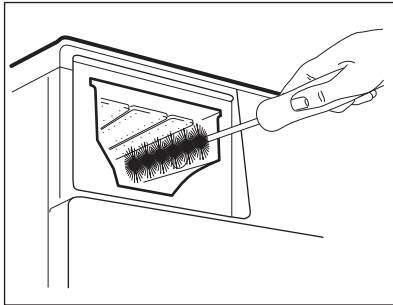

4.

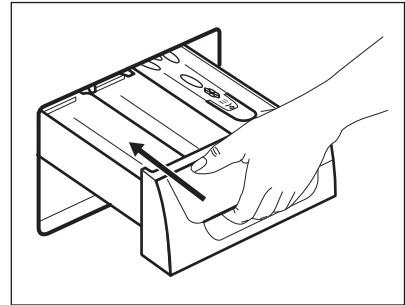

11.7 Cleaning the inlet hoses and the valve filters

Clean regularly both (for hot and for cold water) inlet hoses and both valve filters.

1.

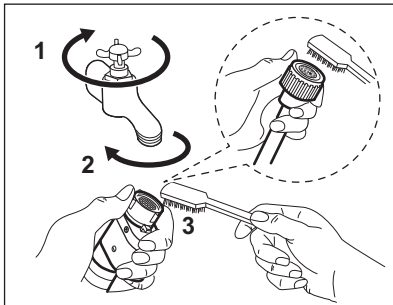

2.

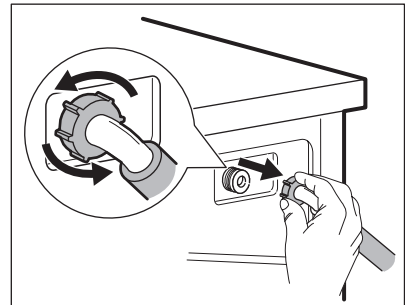

3.

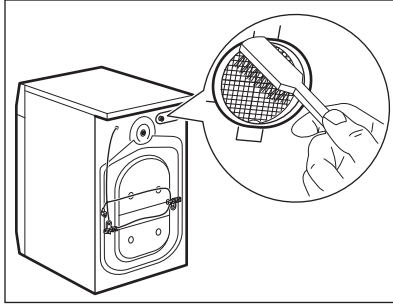

4.

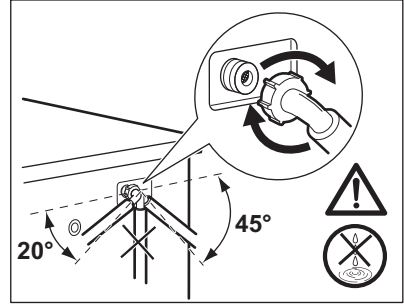

12. TROUBLESHOOTING



WARNING!
Refer to Safety chapters.

12.1 Introduction

The start of the appliance does not occur or it stops during operation.

First try to find a solution to the problem (refer to the table). If not, contact the Authorised Service Centre.

With some problems, the acoustic signals operate and the display shows an alarm code:

- **E10** - The appliance does not fill with water properly.
- **E20** - The appliance does not drain the water.
- **E40** - The appliance door is open or not closed correctly. Please check the door!
- **E40** - The mains supply is unstable. Wait until the mains supply is stable.
- **E91** - No communication between electronic elements of the appliance. Switch off and switch on again.

- **EFO** - Detergent overdosing.
- **E90** -
 - Check the electrical connection first.
 - No communication with the coin operated machine or the coin operated machine doesn't work. Check the connection between coin meter and appliance first, if the problem is not solved, contact the Authorised Service Centre.
 - No communication with the external detergent dispenser. Check the connection between detergent dispenser and appliance first, if the problem is not solved, contact the Authorised Service Centre.



WARNING!
Deactivate the appliance before you do the checks.

12.2 Possible failures

Problem	Possible solution
The programme does not start.	<ul style="list-style-type: none"> • Make sure that the mains plug is connected to the mains socket. • Make sure that the appliance door is closed. • Make sure that there is not a damaged fuse in the fuse box. • Make sure that the Start/Pause has been pressed. • Deactivate the Child Lock function if it is on.
The appliance does not fill with water properly.	<ul style="list-style-type: none"> • Make sure that the water tap is open. • Make sure that the pressure of the water supply is not too low. For this information, contact your local water authority. • Make sure that the water tap is not clogged. • Make sure that the filters of the inlet hoses and the filters of the valves are not clogged. Refer to "Care and cleaning". • Make sure that the inlet hoses have no kinks or bends. • Make sure that the connections of the water inlet hoses are correct.
The spin phase does not operate or the washing cycle lasts longer than usually.	<ul style="list-style-type: none"> • This problem may be caused by balance problems.
There is water on the floor.	<ul style="list-style-type: none"> • Make sure that the couplings of the water hoses are tight and there is not water leakages. • Make sure you use the correct detergent and the correct quantity of it.
You cannot open the appliance door.	<ul style="list-style-type: none"> • Make sure that the washing programme is finished. • Make sure that the appliance receives electrical power. • This problem may be caused by a failure of the appliance. Contact the Authorised Service Centre. If you need to open the door, please read carefully «Emergency door opening».
The appliance makes an unusual noise.	<ul style="list-style-type: none"> • Make sure the levelling of the appliance is correct. Refer to 'Installation'. • Make sure that the packaging and/or the transit bolts are removed. Refer to 'Installation'. • Add more laundry in the drum. The load may be too small.
The cycle is shorter than the time displayed.	<ul style="list-style-type: none"> • The appliance calculates a new time according to the laundry load. See the 'Consumption Values' chapter.
The cycle is longer than the time displayed.	<ul style="list-style-type: none"> • An unbalanced laundry load increases the duration time. This is a normal behaviour of the appliance.

Problem	Possible solution
The washing results are not satisfactory.	<ul style="list-style-type: none"> • Increase the detergent quantity or use a different detergent. • Use special products to remove the stubborn stains before you wash the laundry. • Make sure that you set the correct temperature. • Decrease the laundry load.
The drum light does not go on.	<ul style="list-style-type: none"> • Make sure that you activate the appliance. Refer to "Daily Use" chapter.

After the check, activate the appliance. The programme continues from the point of interruption.

If the problem occurs again, contact the Authorised Service Centre.

If the display shows other alarm codes. Deactivate and activate the appliance. If the problem continues, contact the Authorised Service Centre.

13. EMERGENCY DOOR OPENING

In case of power failure or appliance failure the appliance door remains locked. The washing programme continues, when the power is restored. If the door remains locked in case of failure, it is possible to open it using the emergency unlock feature.

Before opening the door:



CAUTION!

Make sure that the water temperature and the laundry are not hot. Wait till they cool down, if necessary.



CAUTION!

Make sure that the drum is not rotating. Wait till the drum stops rotating, if necessary.



Make sure that the water level inside the drum is not too high. Proceed with an emergency drain, if necessary (refer to «Emergency drain» in «Care and cleaning» chapter).

To open the door, proceed as follows:

1. Press the button ① to switch the appliance off.
2. Disconnect the mains plug from the mains socket.
3. Open the filter flap.
4. Pull the emergency unlock trigger downward once. Pull it downward once again, keep it tensed and, in the meanwhile, open the appliance door.

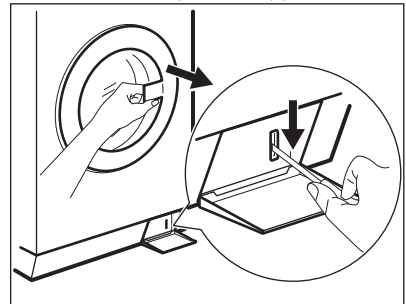

5. Take out the laundry and then close the appliance door.
6. Close the filter flap.

14. TECHNICAL DATA

Dimension	Width/ Height/ Total depth	600 mm/ 850 mm/ 605 mm/ 639 mm
Electrical connection	Voltage	230 V
	Overall power	2200 W
	Fuse	10 A
	Frequency	50 Hz
Level of protection against ingress of solid particles and moisture ensured by the protective cover, except where the low voltage equipment has no protection against moisture		IPX4
Water supply pressure	Minimum	0.5 bar (0.05 MPa)
	Maximum	10 bar (1.0 MPa)
Emission sound pressure level in accordance with EN ISO 11204/11203		< 70 dB
Water supply ¹⁾		Cold water Hot water ²⁾
Maximum Load	Cotton	8 kg
Energy Efficiency Class		A+++
Spin Speed	Maximum	1351 rpm

1) Connect the water inlet hose to a water tap with a 3/4" thread.

2) Make sure that the hot water temperature of your domestic system is not higher than .



The appliance also works by connecting the only cold water pipe.

15. ENVIRONMENTAL CONCERNS

Recycle materials with the symbol . Put the packaging in relevant containers to recycle it. Help protect the environment and human health by recycling waste of electrical and electronic appliances. Do

not dispose of appliances marked with the symbol  with the household waste. Return the product to your local recycling facility or contact your municipal office.

EAC



Electrolux Professional S.p.A.
Viale Treviso, 15 -33170 Pordenone
Italy

www.electroluxprofessional.com/mypro/